

WARNING: DISCONNECT POWER AT THE MAIN FUSE BOX BEFORE INSTALLATION.

WARNING:

This fixture is intended for installation in accordance with the National Electrical Code (NEC) and all local code specifications. If you are not familiar with code requirements, installation by a certified electrician is recommended.

Before assembly, remove all parts and part packages from box. If anything is missing, please contact the retailer from which the product was purchased.



ANY QUESTIONS CALL: 800-613-3261
M-F 8:30AM-5:00PM ET

ITEM#: 85311/1

1. Carefully pull house wires out of junction box so they are easily accessible during installation.
2. Position mounting bracket (A) so the head of the attached ground screw is pointing down towards floor.
3. Place mounting bracket (A) up against junction box. Align each slot in mounting bracket (A) with each hole in junction box.
4. Thread one junction box screw (B) into one slot in mounting bracket (A) and into hole in junction box. Thread second junction box screw (B) into second slot of mounting bracket (A) and into hole in junction box.
5. Tighten junction box screws (B) to secure mounting bracket (A) to junction box.

CAUTION: Make sure house wires are still easily accessible. **DO NOT** pinch wires between mounting bracket and ceiling.

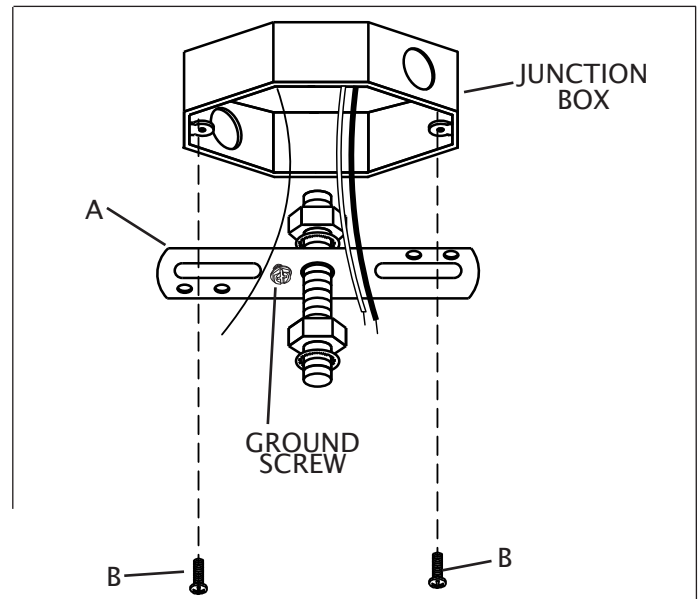

6. Pass end of fixture wires through hole in center of canopy (D).
7. The length of the cord must be adjusted before fixture is installed. Hold canopy (D) against ceiling to determine desired hanging height of fixture.
8. After establishing the desired length of cord, if there is excess cord and wire you may cut cord and wire to remove excess.
9. Cut cord (H) and wire to desired length. Leave approximately 10 inches of cord and wire. To expose fixture connection wires from inside cord cover, using a utility knife, carefully cut outer cord cover and rubber cord cover. **CAUTION:** DO NOT cut fixture wires. Remove enough of the cord cover and rubber cover to expose approximately 6 inches of fixture connection wires.
10. If strain relief (V) needs to be repositioned on cord, loosen set screw on strain relief (V). DO NOT completely remove set screw. Slide strain relief (V) up or down the cord (H).

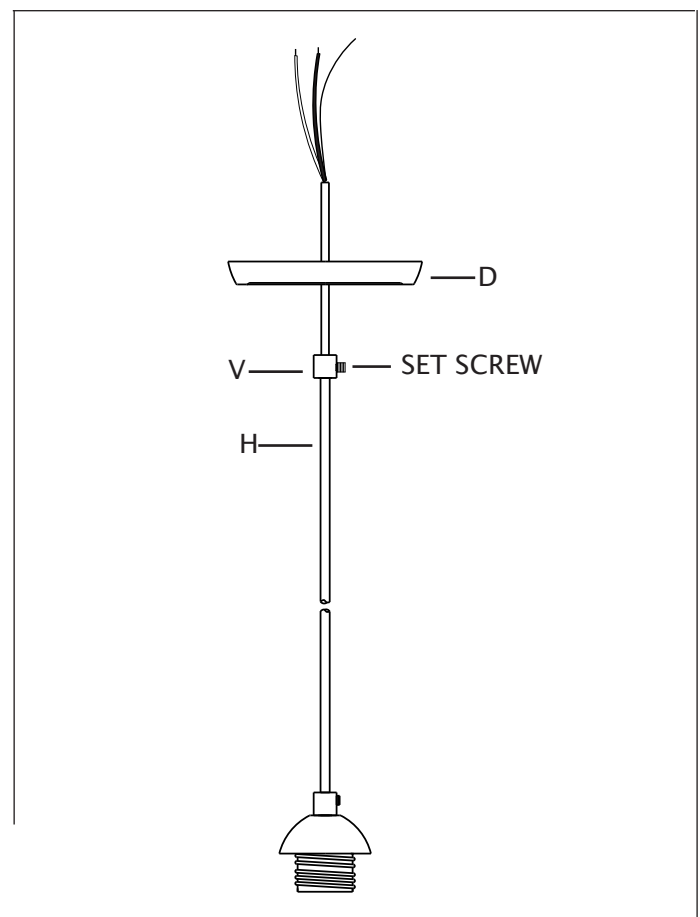

11. Strip 3/4" of insulation from ends of fixture wires.
12. Carefully push fixture wires up through end of threaded pipe on mounting strap (A). Pull fixture wires out of top of threaded pipe.

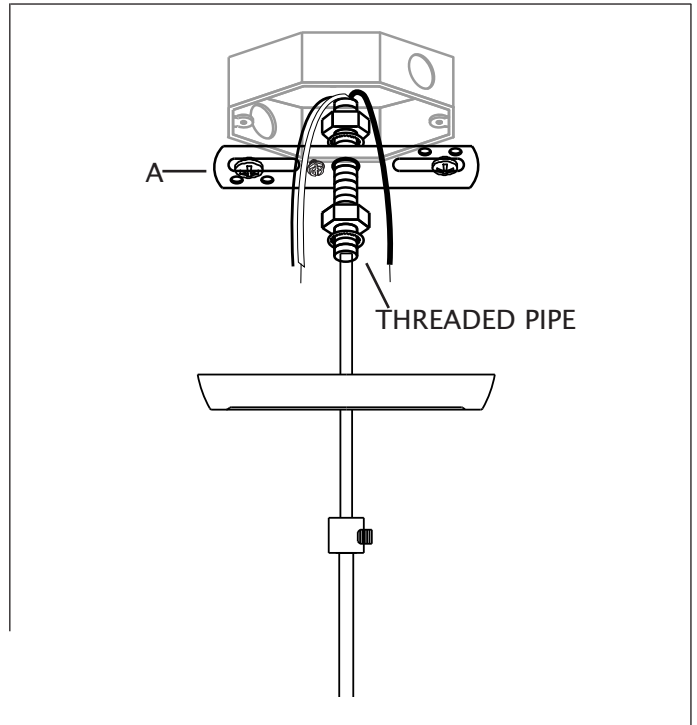

13. Slightly loosen ground screw on mounting bracket (A). Do not completely remove ground screw. Wrap house ground wire (copper) around ground screw, leaving enough ground wire to attach to fixture ground wire (bare copper). Twist end of fixture ground wire (bare copper) and end of house ground wire (copper) together. Twist wire nut (C) onto ends of wires. Completely tighten wire nut (C).

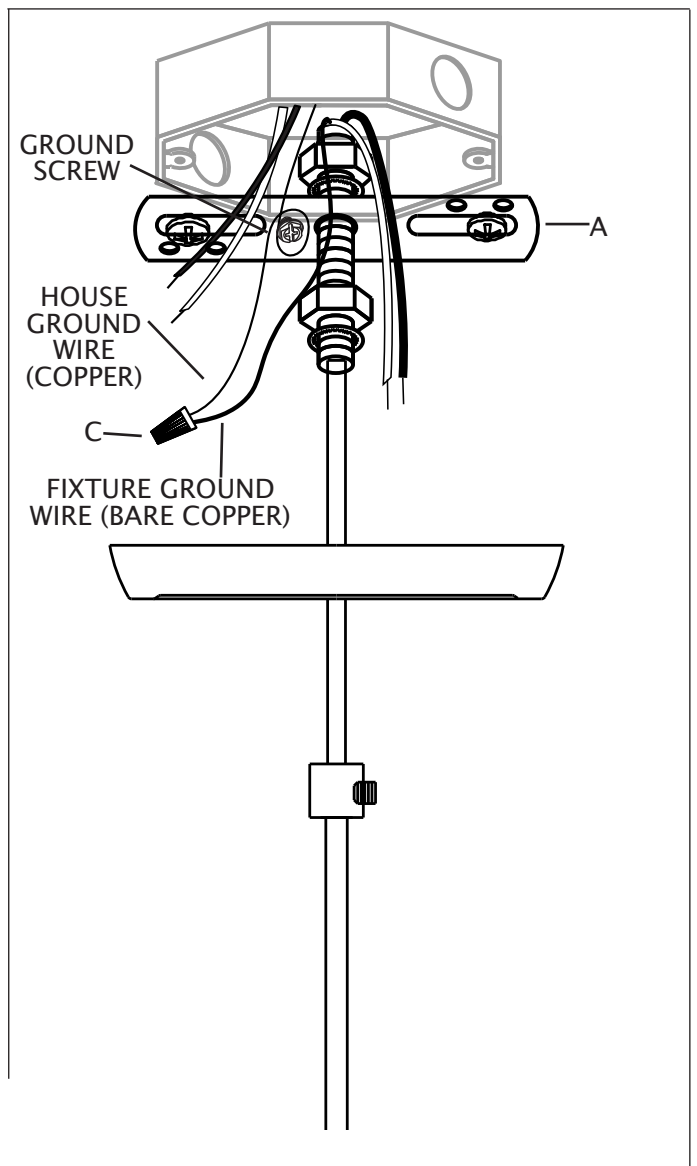

14. Twist end of house lead wire (black) and end of fixture lead wire (black) together. Twist wire nut (C) onto ends of wires. Completely tighten wire nut (C). Twist end of house neutral wire (white) and end of fixture neutral wire (white) together. Twist wire nut (C) onto ends of wires. Completely tighten wire nut (C).
15. Wrap electrical tape (not included) around wire nuts (C) and wires. Ensure wires are securely fastened into wire nuts.
16. Carefully push all wires and wire nuts into junction box.

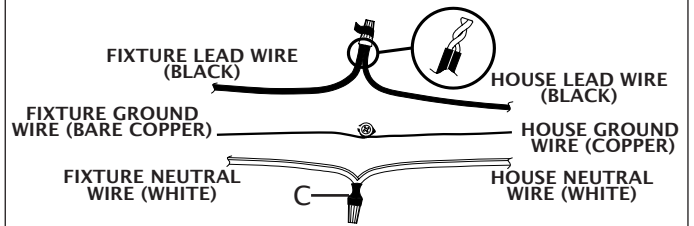

17. Raise canopy (D) up to ceiling. Pass hole in center of canopy (D) over end of threaded pipe on mounting strap (A).
18. Loosen set screw on strain relief (V). Slide strain relief (V) up the cord (H). Thread strain relief (V) onto end of threaded pipe. Tighten strain relief (V) to secure canopy up against ceiling. Tighten set screw on strain relief (V).

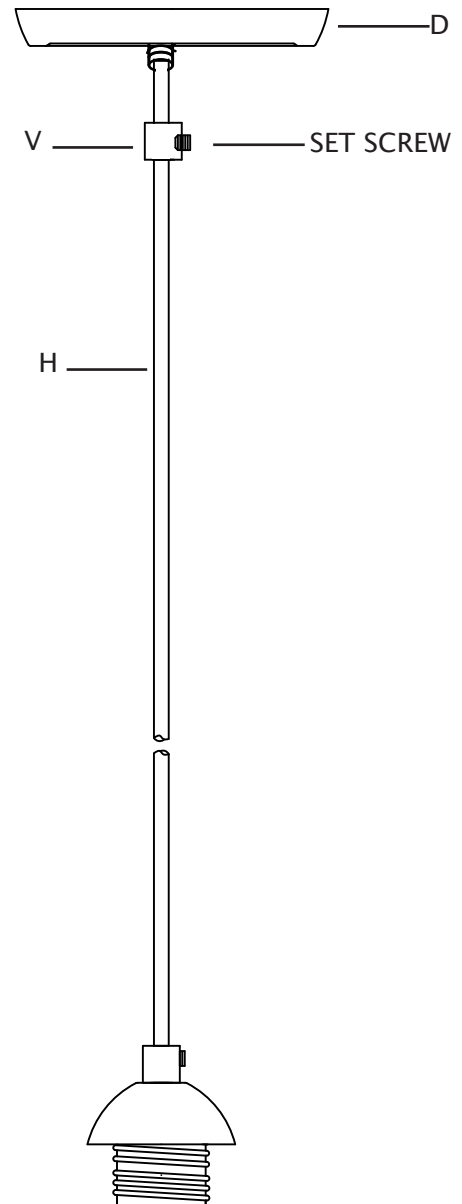

19. Raise shade (K) up to fixture. Pass hole in top of shade (K) over socket.
20. Thread socket ring (L) onto socket. Tighten socket ring (L) to secure shade (K) in place. DO NOT over tighten.
21. Screw recommended bulb (E26 Edison bulb type, not included) into socket. Verify correct bulb wattage marked on socket of fixture.
WARNING: DO NOT exceed maximum bulb wattage.

